

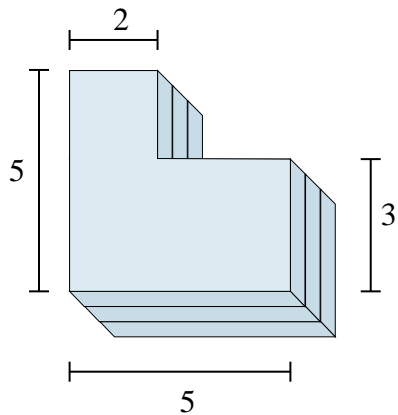

Find the total volume of each figure shown. Measured in cm (not to scale).

Answers

1)



2)

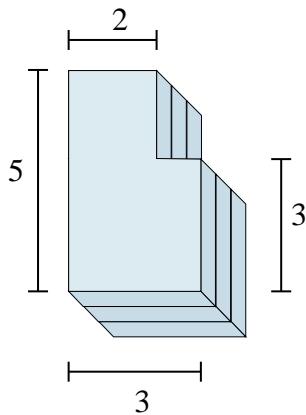

3)

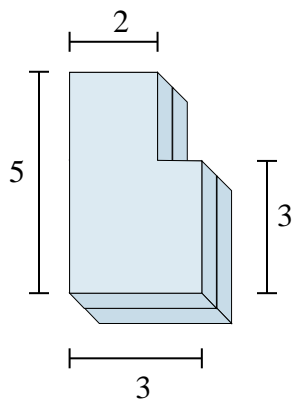

4)

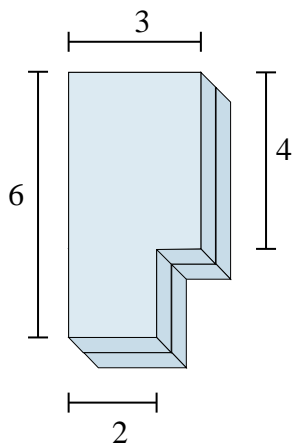

5)

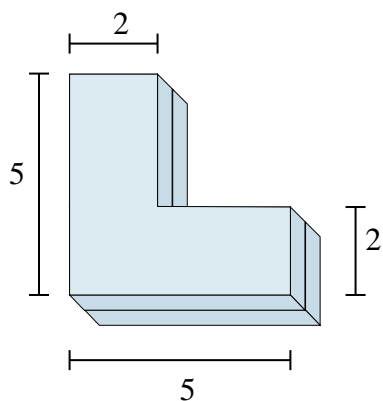

6)

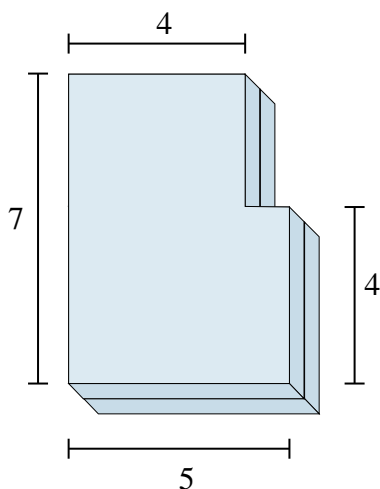

- 1. \_\_\_\_\_
- 2. \_\_\_\_\_
- 3. \_\_\_\_\_
- 4. \_\_\_\_\_
- 5. \_\_\_\_\_
- 6. \_\_\_\_\_



Find the total volume of each figure shown. Measured in cm (not to scale).

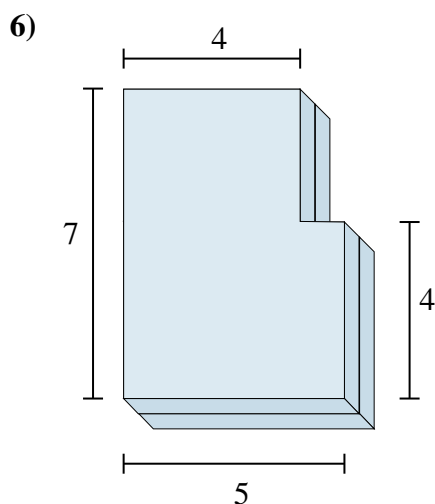
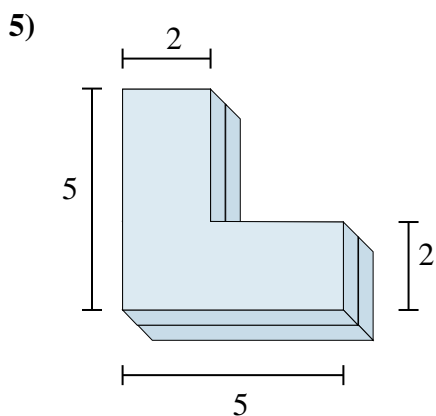
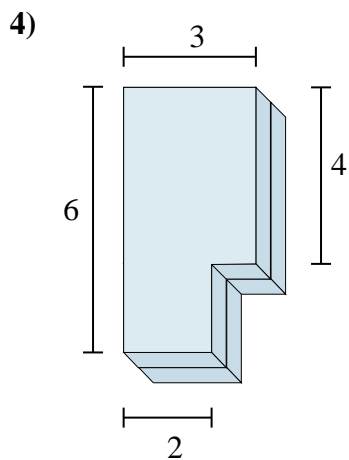
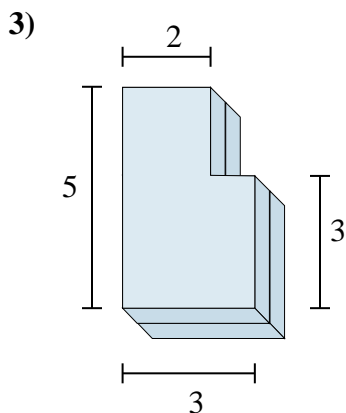
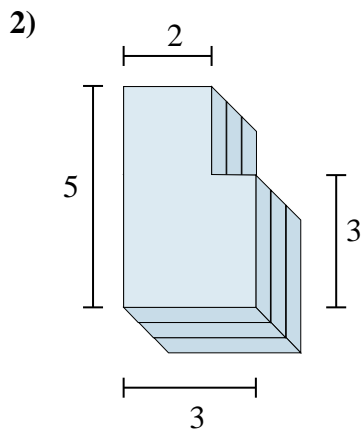
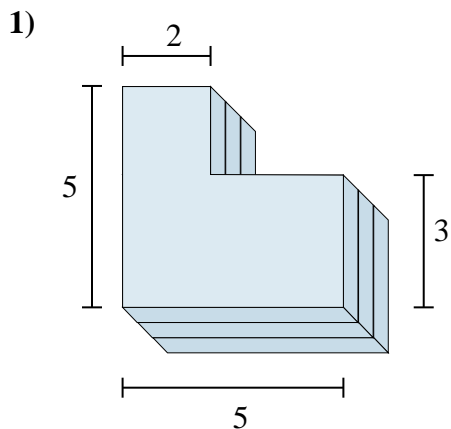

Answers

1. **57 cm<sup>3</sup>**

2. **39 cm<sup>3</sup>**

3. **26 cm<sup>3</sup>**

4. **32 cm<sup>3</sup>**

5. **32 cm<sup>3</sup>**

6. **64 cm<sup>3</sup>**



Find the total volume of each figure shown. Measured in cm (not to scale).

Answers

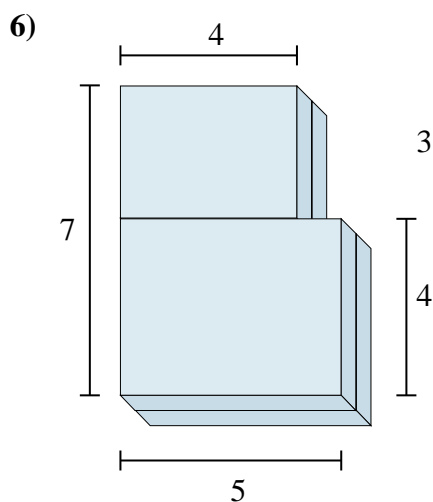
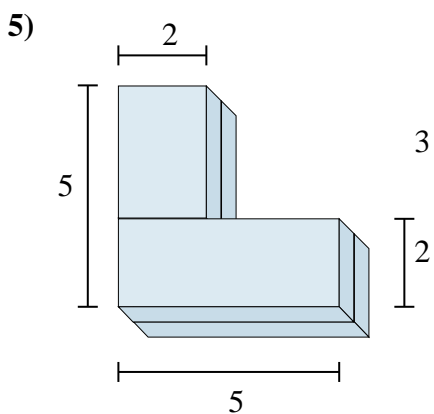
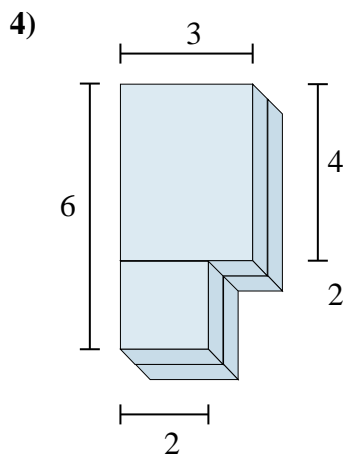
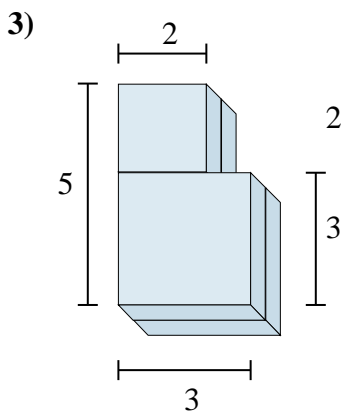
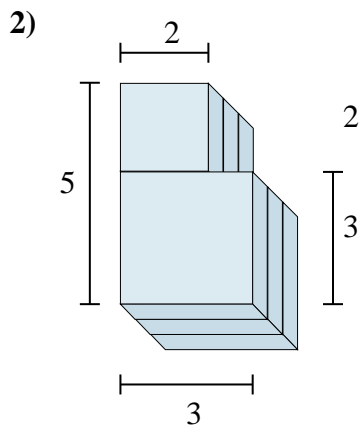
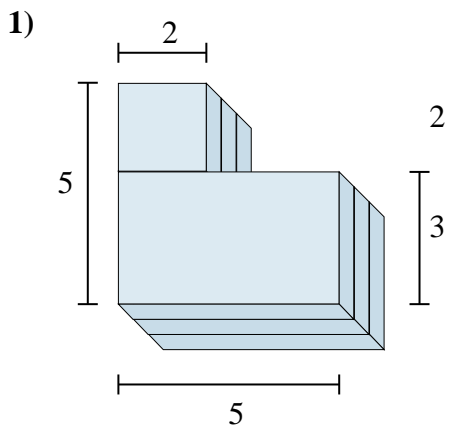

1. \_\_\_\_\_
2. \_\_\_\_\_
3. \_\_\_\_\_
4. \_\_\_\_\_
5. \_\_\_\_\_
6. \_\_\_\_\_